

15 Watts Monitor / Wall mount Loudspeaker

APPLICATION

- Public Address and Voice Alarm
- Outdoor application
- Background Music

AREA OF USE

- Health • Education • Retail • Hospitality
- Stadiums • Transportation • Theme parks • Military



EN 54 | 24

- Distinctive design
- Excellent sound
- IP 65

OVERVIEW

The compact monitor speaker impresses by a sophisticated design and by its powerful sound. Perfectly suitable for installations where high sound quality is needed.

The 15W powered speaker is equipped with a high quality 2-way system and a 100V transformer with 3 power adjustments. Also, the low impedance operation with 8 ohm is possible. The impact-resistant, UV-resistant ABS plastic housing in black assures enduring stability. For additional reliability, a wetness impregnation of the speaker is provided.

The speaker is also secured with protection class IP 65 against the risks of environmental influences.

A comfortable connection of the speaker is made possible by a stable screw terminal with contact protection. Quick and easy mounting with wall mounting bracket.

POLAR DIAGRAMS

Polar Diagram 500Hz

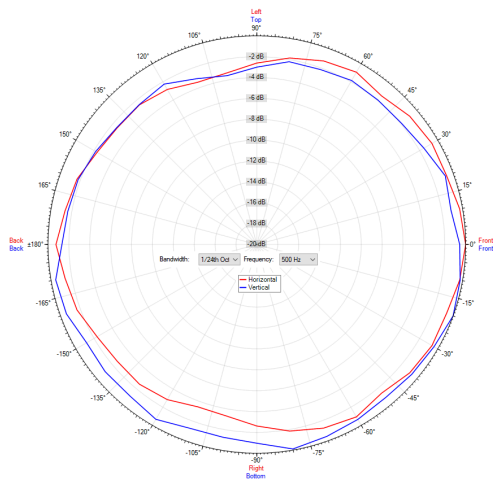

Polar Diagram 4000Hz

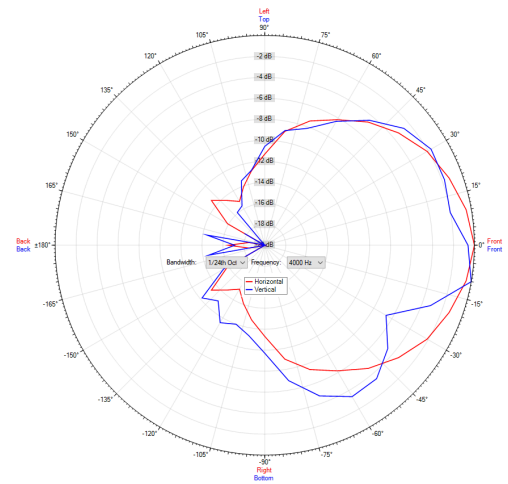

Polar Diagram 1000Hz

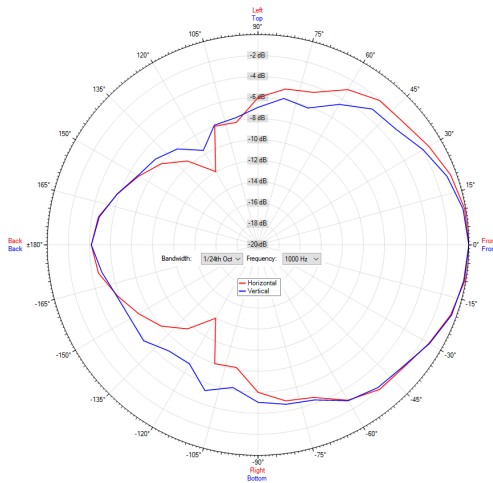

Polar Diagram 8000Hz

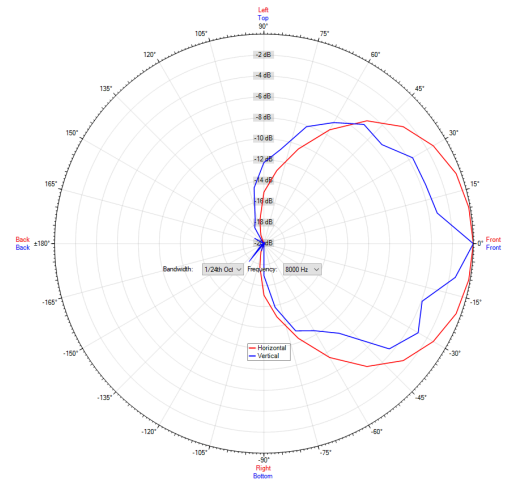

Polar Diagram 2000Hz

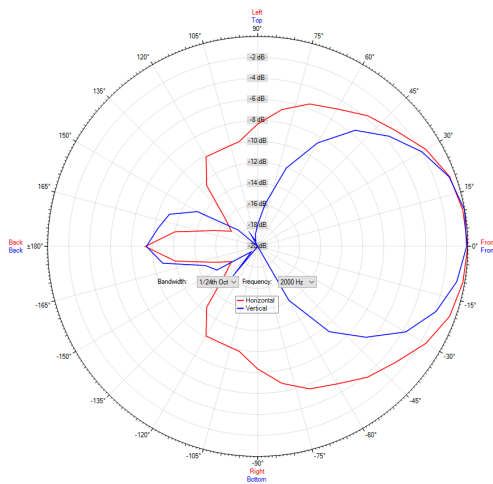

FREQUENCY RESPONSE DIAGRAMS

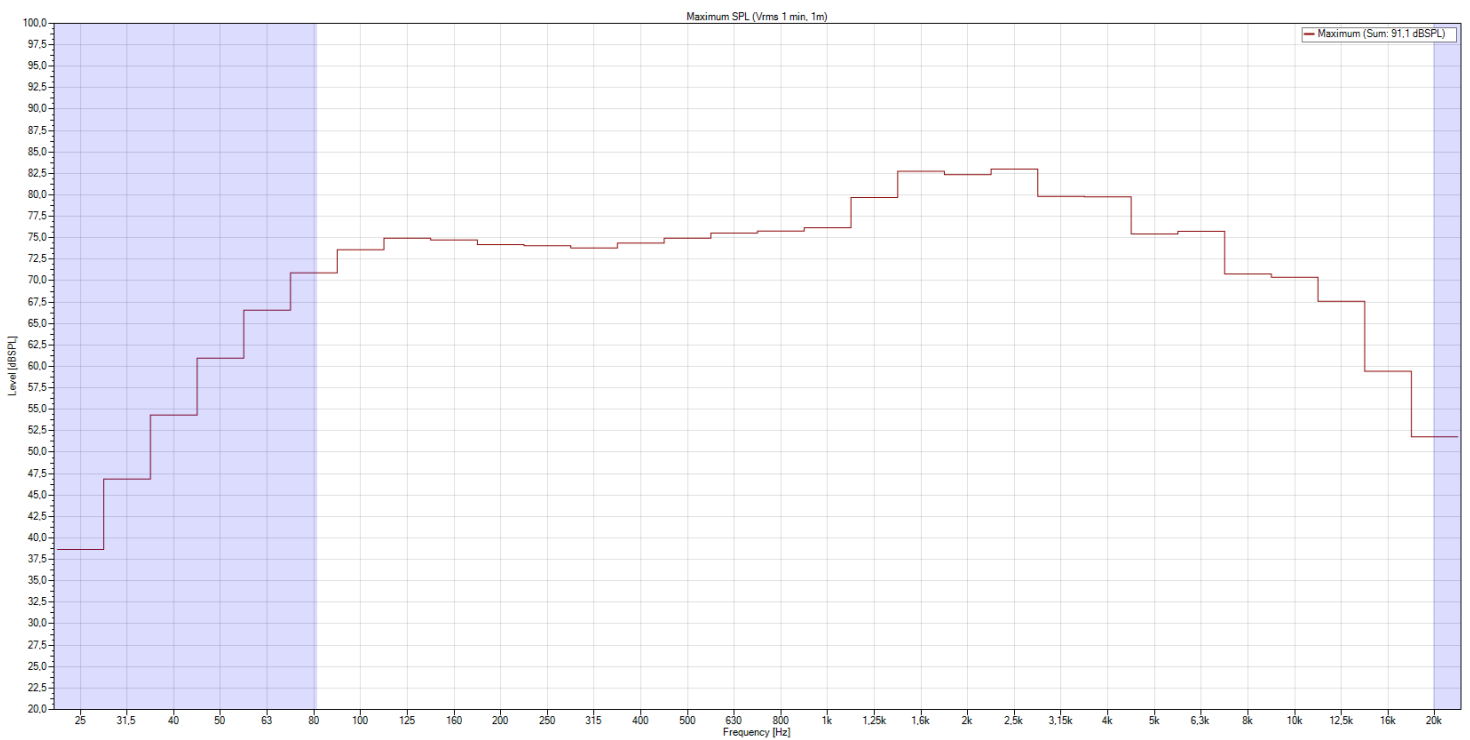
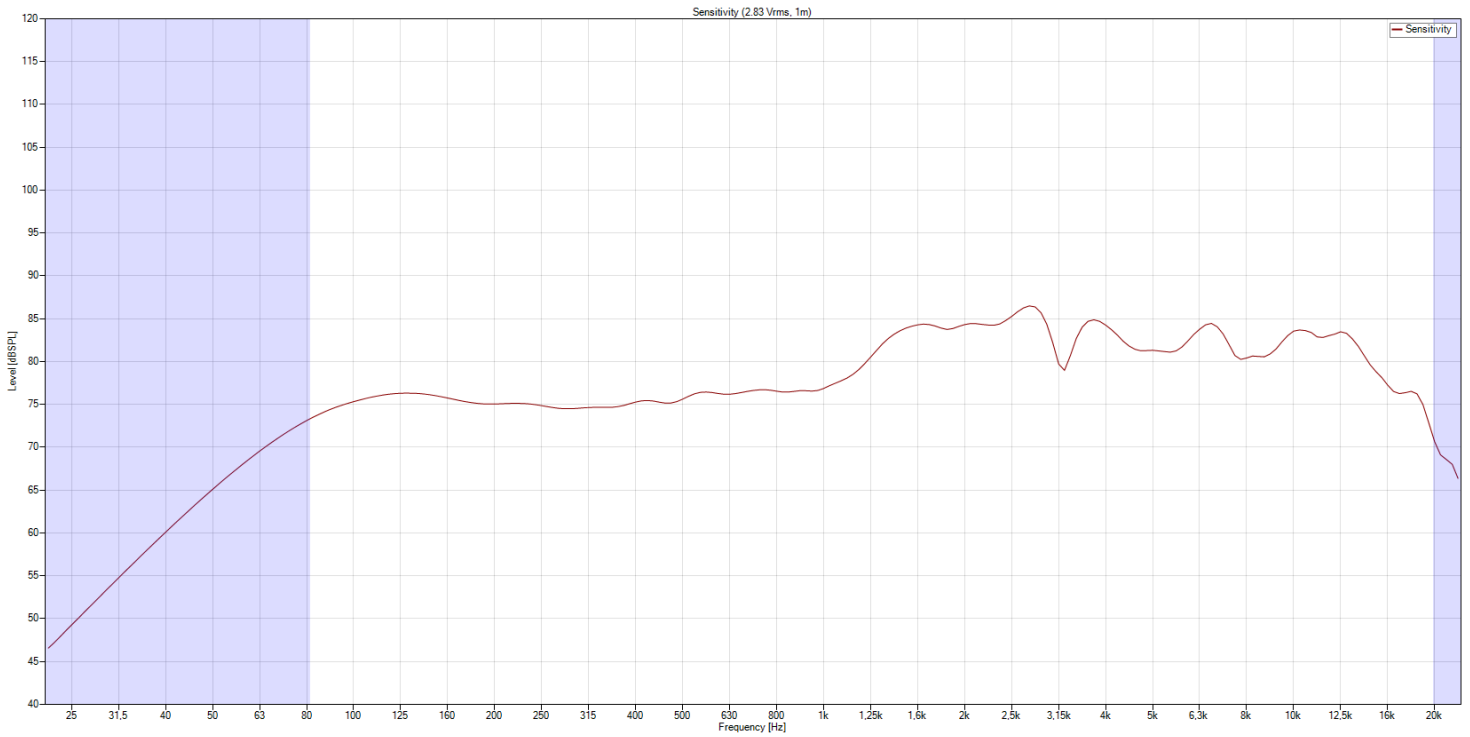

ISOBAR

Vertical

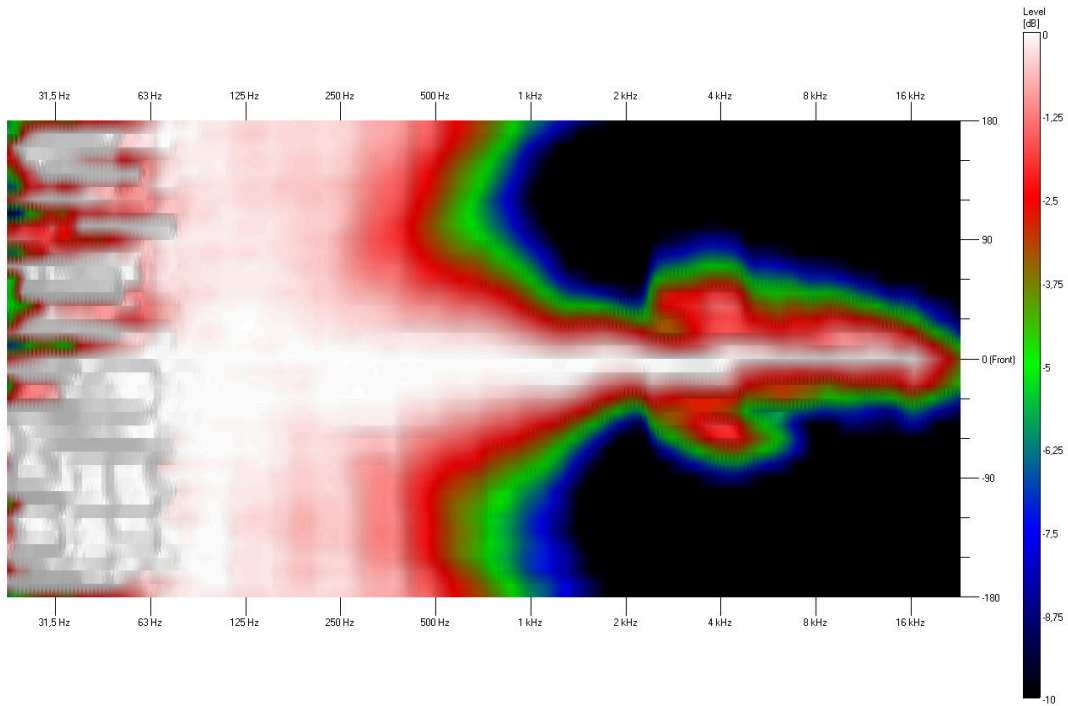

Horizontal

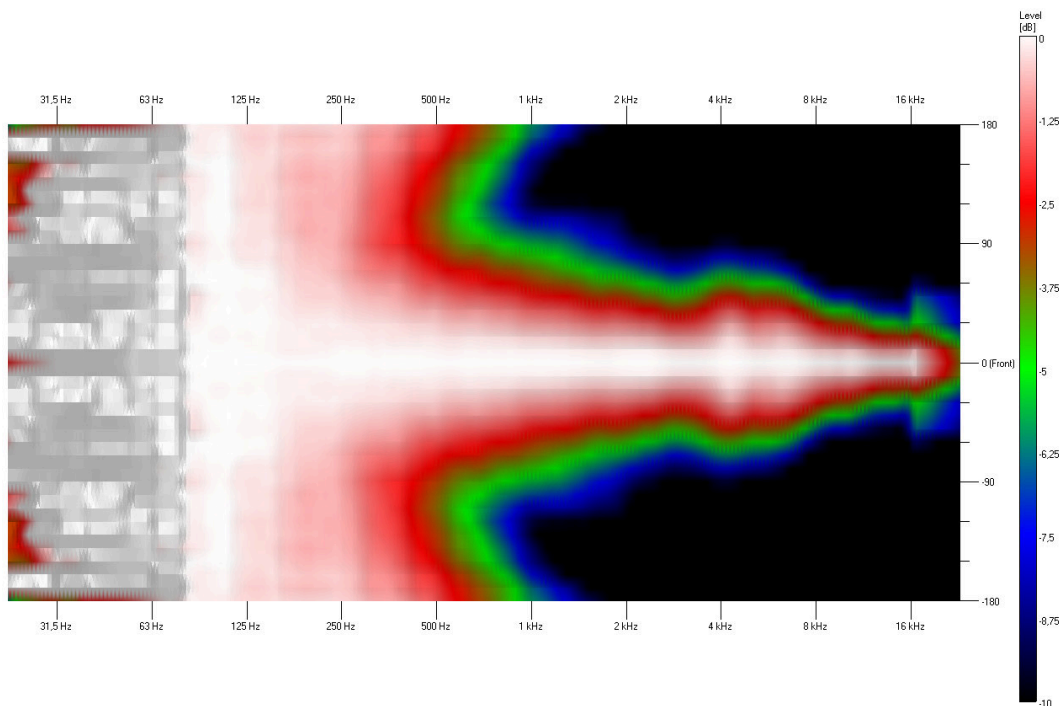

TECHNICAL DIAGRAMS

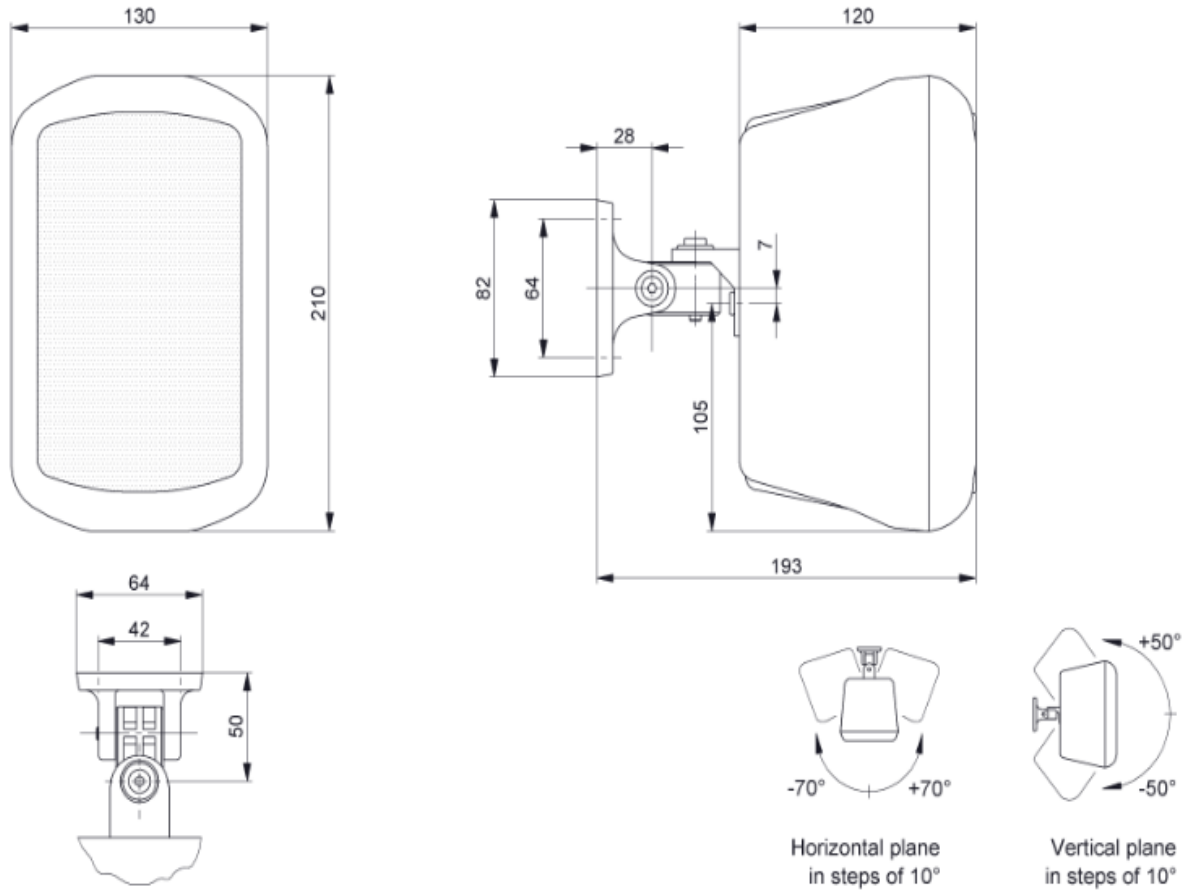

all dimensions are in mm

TECHNICAL DATA (ELECTRICAL)

Description	WMS-15B-ABS
Power	15/7,5/3,75/1,8 (8ohm) W
Impedance (100V)	667/1333/2667/5000 ohm
Frequency Range	67 - 21.000 Hz
Frequency Response	55 - 24.000 Hz
Sensitivity IEC268-5 , 1W/1m	80,2 dB
Sensitivity EN54-24, Pmax/4m	81,0 dB
Sensitivity EN54-24, 1W/4m	68,2 dB
Sensitivity EN54-24, 1W/1m	80,2 dB
Dispersion -6dB, 500Hz	h/v 360
Dispersion -6dB, 1KHz	h 220° v 190°
Dispersion -6dB, 2KHz	h 135° v 130°
Dispersion -6dB, 4KHz	h 150° v 165°

TECHNICAL DATA (MECHANICAL)

Dimensions	210x130x120 mm
IP Rating	IP65
Weight (net)	2,0 kg
Temperature range	-25 / +70 °C
Mounting	Swivel bracket
Connector	6-pin screw terminal
Terminal Diameter	2,5 mm
Maximum Cable Passage	4,9mm ²
Colour	black

All rights reserved.

The information contained in this document is believed to be accurate; however, no representation or warranty is given, and pAudio Technologies assumes no liability regarding its accuracy or completeness.